

profile 31x31

RANGE	PROFILE 31X31
REF.	QBOP31X-
TYPE	SURFACE PROFILE
DIMENSIONS	31 x 31x 3000 mm
WEIGHT	1,79 kg
MATERIAL	ALUMINIUM
ALLOY	6063
RESISTANCE	T5
ANODIZE	20µm
FINISH	ALUMINIUM

*Diferentes acabados y opciones de protección IP disponibles bajo pedido
Other finishes and IP ratings available on request

*Compatible con todas las potencias y medidas de tiras de LED qbo Flexy
Compatible with all power and measures of qbo Flexy LED strips

*Todos los perfiles qbo se extruyen a partir de la aleación 6063 de aluminio reciclado de segunda fusión.
All qbo profiles are extruded from 6063 recycled aluminum alloy, at least second fusion.

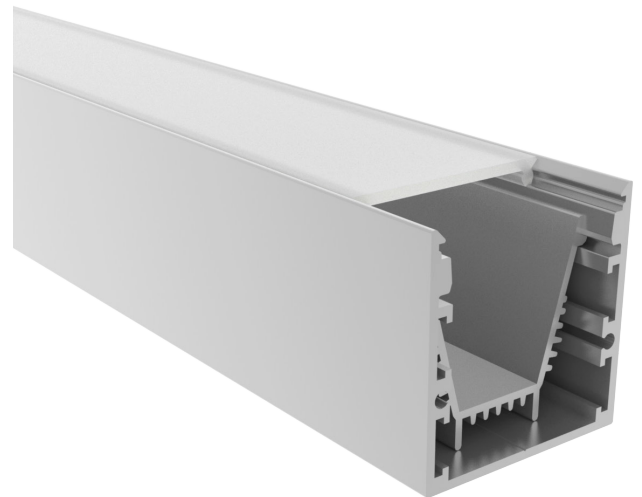

CODE	DESCRIPTION
QBOP31X13S	PROFILE 31x31 surface 3000mm
QBOP31X31DF	PROFILE 31x31 diffuser frosted 3000mm
QBOP31X31DP	PROFILE 31x31 diffuser prismatic 3000mm
QBOP31X31H	PROFILE 31x31 heat sink 3000mm
QBOP31X31C	PROFILE 31x31 end caps surface (2 units)

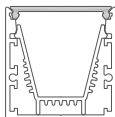
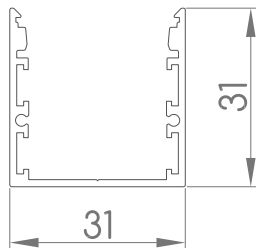

QBOP31X31DP

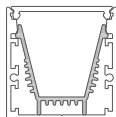

QBOP31X31H

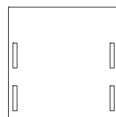

QBOP31X31C

profile 31x31^{acc}

CODE	DESCRIPTION
QBOP01UL	PROFILE 01 6x1mm linear union (2 units)
QBOP01UAE	PROFILE 01 6x1mm angular union (2 units)
QBOP01UAP	PROFILE 01 6x1mm angular union flat (2 units)

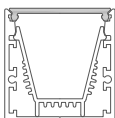

QBOP31X31DF



QBOP01UL



QBOP01UAE

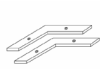

QBOP01UAP